

M92

MODEL AAKACZ130 OR AAKACZ132
INSTRUCTION MANUAL

型號
AAKACZ130
AAKACZ132
系列操作說明書



PISTOL

- MECHANICAL AIR SOFT SPRING 6mm
- FIXED HOP UP SYSTEM AAKACZ130 SYSTEM
- FIXED NON-HOP UP SYSTEM AAKACZ132 SYSTEM
- 12 rds. 6mm BB(0.24)
- 0.6 joule MAX 78 m/s VELOCITY
- MATERIAL 355g FULL ADS
- LENGTH 215mm
- BLACK MAGAZINE AAK ACS130A
- SILVER MAGAZINE AAK ACS130B

KWC KIEN WELL TOY INDUSTRIAL CO., LTD
www.kwcgun.com

台南市仁德區義林路168巷89號
NO.89, LN. 168, YILIN RD.,
RENDE DIST., TAINAN CITY
71752, TAIWAN (R.O.C.)
TEL: +886-6-2798175
FAX: +886-6-2798176
sales@kwcgun.com
www.kwcgun.com

低動能遊戲用槍AAKACZ13系列

1.安全裝置：保險作用為防止誤扣扳機時而不至於擊發

- ★請參考右邊圖片，為本型號保險開關使用方法。
- ★請務必聽到切換時保險開關的聲音，以確定保險是處於安全而正確的位置。

保險關閉，可擊發 保險開啓，不可擊發

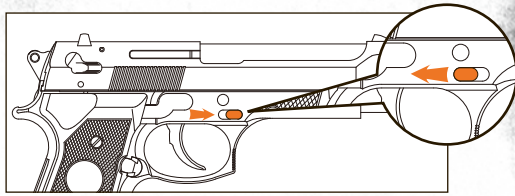

2.裝彈方法：請使用 KWC 指定的BB彈

- ★壓下彈匣卡榫後便可抽出彈匣

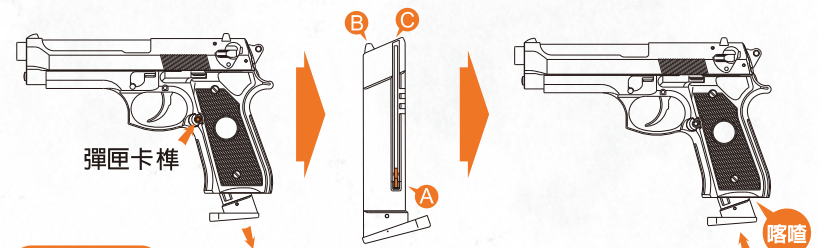

注意

- A. 本公司為了提高此空氣槍的命中率起見，槍身採用非常精密的槍管。
- B. 請勿使用非本公司指定及品質粗糙的BB彈射擊。因為這些都是造成卡彈及其他種類故障的原因，請注意若強行使用而導致故障發生時，本公司將不負責一切的修理。

- A. 將滑粒壓到底端並使其固定住。
 - B. 壓下子彈卡榫，以便裝填子彈。
 - C. 將BB彈裝入(最多12發)。
- ★將彈匣插入，直到聽到“喀嗒”聲響後才停止。

3.射擊操作：

- A. 將保險推到“射擊時”狀態。
- B. 將上蓋往後拉到底，聽到“喀嗒”聲響。
- C. 確認上蓋是否確實彈回原位。(若上蓋未完成回到原來位置而扣引扳機的話，槍身內部活塞將會損壞)
- D. 扣引扳機後BB彈被發射出去。
- E. 若不再繼續發射時，將保險推到“不射擊時”狀態。



注意

- A. 保管時請將彈匣抽出，並指向安全的方向射擊，務必確定槍中已無BB彈殘留才行。
- B. 彈匣移除後，並將保險推到“不射擊時”狀態，保管在小孩子無法拿得到的安全場所。
- C. 請勿將槍在待擊發狀態下做長時間的放置或保管。(此將是發射彈簧性能低下的原因)

WARNING 請務必嚴格遵守 使用操作說明書

此低動能遊戲用槍是針對喜愛射擊運動的消費者所開發。避免因使用方法不正確或改造所發生的故障或事故，請務必詳讀說明書，正確的操作享受愉快的射擊運動。

- 除了發射時外，不要將手指頭掛在板機上。
- 選擇安全與適當標靶
- 在非使用期間，請保持保險關閉且退彈的狀態，就算在非使用狀態，也要如同其已裝彈。
- 如任何的機械產品，槍的保險也可能失效。即使在保險關閉的狀態下也請小心的操作此槍，請勿將槍口對人。
- 千萬不要對堅硬或平坦表面、水面射擊，以避免跳彈。
- 請妥善保管產品在未成年孩童無法伸手取得的場所。
- 每次使用前後都應該檢查擋彈物，假如擋彈物表面有磨損失效或是反彈時請停止使用。
- 請使用高品質BB彈，請勿使用①口徑大於6mm②表面不平滑的③重複使用過的BB彈④非本說明書指名的發射物。
- 檢查任何掉落之槍枝，以確保未影響其功能。

- ★使用玩具槍前，請務必戴上保護眼鏡或面罩。
- ★使用玩具槍前，請務必詳讀說明書內容。
- ★請不要在公開場合使用玩具槍，也請不要拿玩具槍對準人或動物。
- ★請確認後再發射BB彈方向，附近無人或動物存在。
- ★不可攜帶玩具槍在公共場所行走，請務必裝在袋子或盒子內。
- ★請不要由槍口向內探視。
- ★不可任意改造或加工玩具槍，私自改造加工會造成產品損壞、保固失效，導致使用上不安全，甚至觸法送辦。

AAKACZ13 系列零件表

圖號	零件名稱	圖號	零件名稱	圖號	零件名稱
P05	槍管接筒	P112	擊鐵連動片	E12	一字特殊3.0X6束黑
P06	氣缸卡榫			E13	槍柄配重
P07	接筒卡榫	Z01	活塞固定座	E14	配重圓棒A
P09	活塞			E15	彈片
P10	彈簧支座	B01	槍管		
P24	活塞卡榫			U1	彈匣組件
P56	氣缸	R01	活塞迫緊	X1	內槍管組件
P57	氣缸後罩	R02	子彈迫緊		
P58	槍身上蓋				
P59	槍管導管	F02	平頭軸(氣缸)		
P60	保險鈕	F03	軸(擊鐵)		
P61	保險卡榫	F12	軸(扳機, 活塞卡榫用)		
P62	扳機	F14	軸(擊鐵箱用)		
P64	擊鐵箱(左)	F15	軸(握柄配件用)		
P65	擊鐵箱(右)				
P66	保險桿	S03	活塞卡榫扭簧		
P67	上蓋定位片	S04	活塞壓簧		
P68	扳機連桿	S05	擊鐵扭簧		
P69	擊鐵	S14	槍管導管壓簧		
P70	握柄配件	S15	扳機壓簧		
P71	本體				
P72	彈匣卡榫	E01	⊕2.3X6尖. 鉸		
P73	槍柄(左)	E09	⊕2.3X10束黑		
P74	槍柄(右)	E10	⊕2.3X8束鉸		
P75	槍管導桿	E11	⊕2.3X6束鉸		

FOR PRIMARY AIRSOFT SPRING GUN SERIES

1. OPERATING THE TRIGGER SAFETY DEVICE:

- ★ Please refer to right side photo for safety switch operation.
- ★ Make sure to hear the click when switching safety on and off to ensure the safety is in proper position.

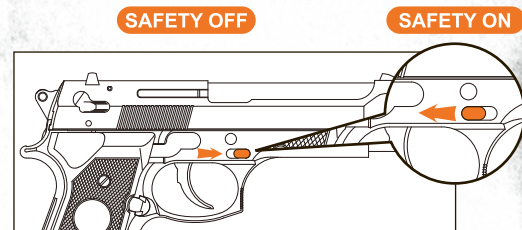

2. LOADING BB: Please use **KWC** granted 6mm BB with this airsoft.

- ★ Press magazine release catch to remove magazine.

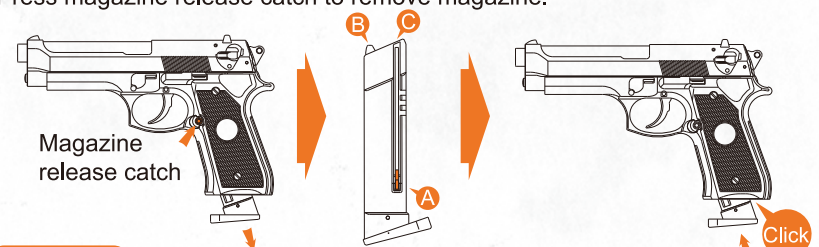

CAUTION

- As our design effort to produce the most accurate airsoft, we utilize precision aluminum or copper inner barrel.
- Only use high quality KWC bbs to ensure safe and trouble free operation. The manufacture and its distribution will not be held liable for any incidental or consquential damages or injuries caused by users using incorrect / improper bbs.

- Pull the magazine follower down and lock it in place by pushing the follower knob over the stopper.
- Press the bb catch lever down and hold it down to load bb.
- Load BB into the magazine. Forcing extra BB into the magazine could damage the follower and the airsoft.

- ★ Firmly re-insert the loaded magazine back into the grip. You will hear a "Click" indicating the magazine is securely locked in place.

3. COCKING AND SHOOTING:

- Switch safety off.
- Pull the slide back until you hear a "Click" indication the shot is locked and ready.
- Make sure that the slide has returned backed to its original position before pulling the trigger. (pulling the trigger before the slide is properly seated will cause internal damage to the air soft gun).
- Pull the trigger to shoot.
- Repeat step B for next shot.
- At the end of use, switch the safety on and remove the magazine.

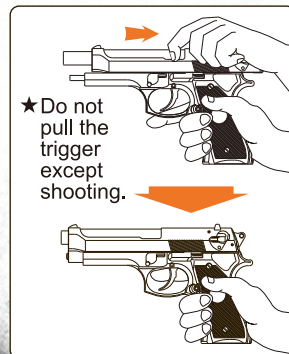

CAUTION when you have finished shooting

- Remove the magazine. Cock and shoot the airsoft again at a safe direction 2 to 3 times to ensure no BB is left in barrel.
- Store the airsoft with magazine removed and safety on. Keep it out of reach of children.
- Keeping the gun cocked for a long period of time will weaken the piston spring which could cause malfunction.
- Please avoid dry firing, for it could cause parts deformed or damage.

WARNING For your safety, please read this manual carefully before use.

This airsoft is intended for recreational or training purposes. To prevent improper handling, modification or alteration causing malfunction or accident, please read the owner's manual carefully. Enjoy the pleasant shooting experience by proper operation.

- Do not put your finger on the trigger except shooting.
- Please choose safe and proper target.
- Please always keep the airsoft on safe and unloaded when not using.
- Like all mechanical devices, an airsoft safety can fail. Always handle the airsoft safely even when the safety is "on safe". Never point the airsoft at any people.
- Avoid ricochet. Never shoot at a hard or flat surface or at water.
- Keep the airsoft out of reach for small children.
- Your backstop should be inspected for wear before and after each use. Discontinue use of the backstop if surface shows signs of failure or ricochet.
- Only use high quality BB. Never use ① BB diameter larger than 6mm ② BB with unsmoothed surface ③ reused BB that has been fired ④ incorrect projectiles not design for this airsoft.
- Check any gun that has been dropped to ensure that its function has not been affected.

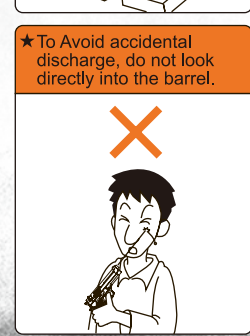
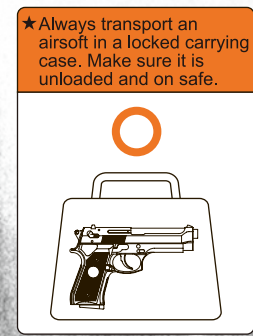

AAKACZ13 SERIES PARTS LIST

NO.	UNIT	NO.	UNIT	NO.	UNIT
P05	BARREL CONNECTOR	P112	HAMMER LINKAGE	E12	SCREW 3.0X6
P06	CYLINDER CATCH			E13	GRIP WEIGHT
P07	CONNECTOR CATCH	Z01	PISTON BASE	E14	REAR GRIP WEIGHT
P09	PISTON			E15	INNER FRAME BASE SPRING
P10	SPRING STOCK	B01	INNER BARREL		
P24	PISTON CATCH			U1	MAGAZINE UNIT
P56	CYLINDER	R01	PISTON PACKING	X1	INNER BARREL UNIT
P57	CYLINDER REAR COVER	R02	RUBBER CHAMBER		
P58	SLIDE				
P59	OUTER BARREL	F02	PIN (CYLINDER)		
P60	SAFETY CATCH	F03	PIN (HAMMER)		
P61	SAFETY CATCH	F12	PIN (TRIGGER, PISTON CATCH)		
P62	TRIGGER	F14	PIN (CHASSIS)		
P64	CHASSIS(L)	F15	PIN (GRIP)		
P65	CHASSIS(R)				
P66	SAFETY	S03	PISTON CATCH SPRING		
P67	SLIDE STOP	S04	PISTON SPRING		
P68	TRIGGER BAR	S05	HAMMER SPRING		
P69	HAMMER	S14	OUTER BARREL SPRING		
P70	GRIP PLUG	S15	TRIGGER SPRING		
P71	FRAME				
P72	MAGAZINE CATCH	E01	SCREW 2.3X6		
P73	GRIP(L)	E09	SCREW 2.3X10		
P74	GRIP(R)	E10	SCREW 2.3X8		
P75	BARREL GUIDE	E11	SCREW 2.3X6		

AAKACZ13 系列零件分解圖 AAKACZ13 SERIES EXPLORED VIEW

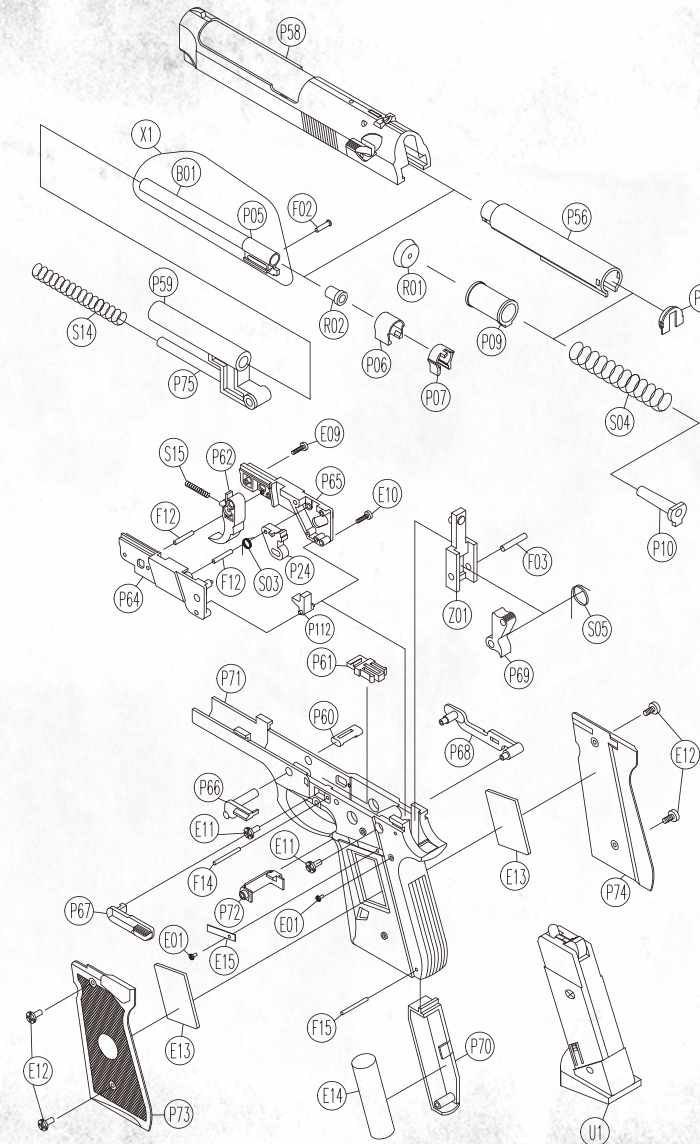

※零件有時為了改良而不經預告變更。
Spare parts may be modified for quality improvement
And such modification may be without advance notice.